

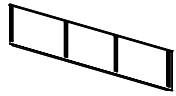

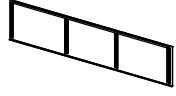

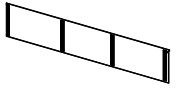

Part ID	Description	Illustration	Qty
A	Left Side Plate		1
B	Right Side Plate		1
C	Rear Wall		1
D	Front Frame		1
E	Shelf		2
F	Middle Shelf		2
G	Door		3
H	Lock		3
I	Door Shaft		1

## BZ-C-A3 Installation Instructions

1. As shown, the C assemble into A, B in

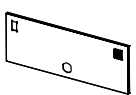
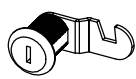

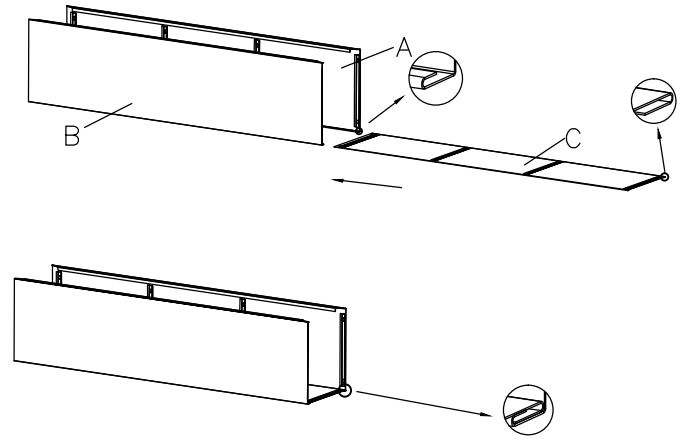
2. Installing the D to the cabinet

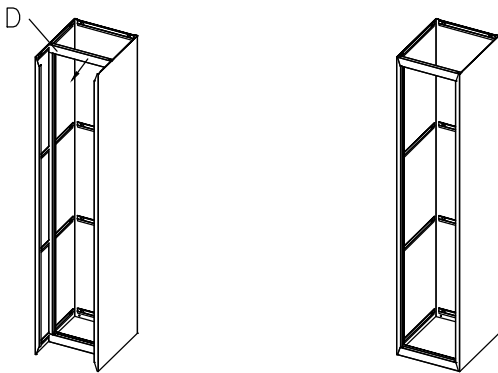

3. Figure, mounted to the cabinet of F

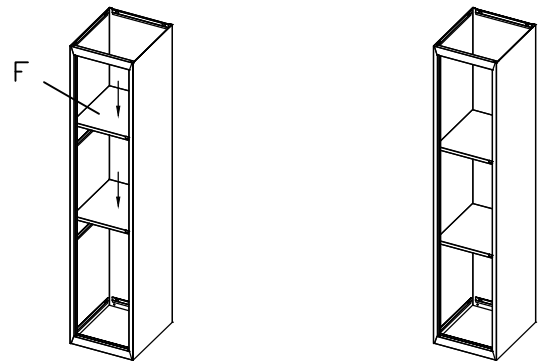

4. The E attached to the cabinet

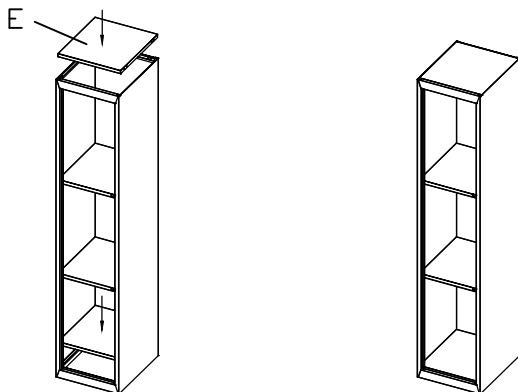

5. Attached to the H on G, then G were installed from the bottom up

