

Vertical File Cabinet Installation Instructions

1: As shown, with Q fixed at C on the N

M4x16-2

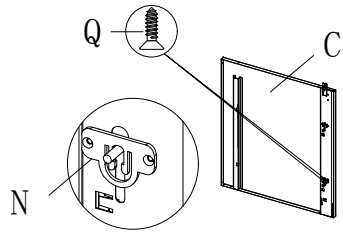

2: The B, C mounting onto A, with P fixed

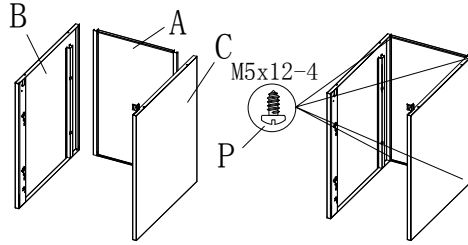

3: D as shown in the attached to B, C

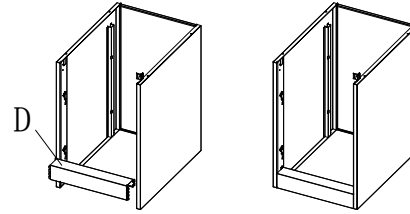

4: The O, E as shown mounted to the cabinet, With P fixed E

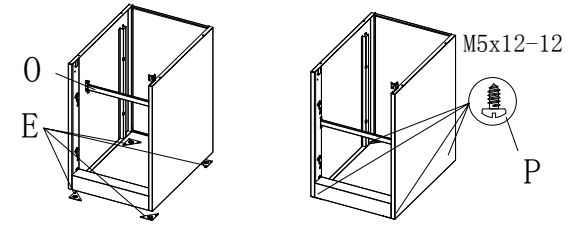

a: Install U to H

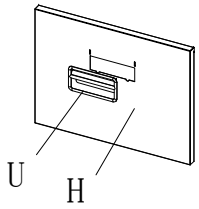

b: Open I

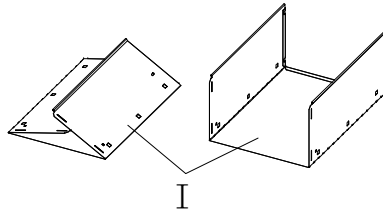

5: F to cabinet installation, with P fixed

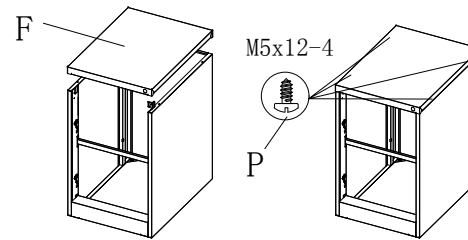

6: As shown installed rails L, G locks (When installing G, there is a note that locks the arrow side up, the rotational direction of the latch is shown below)

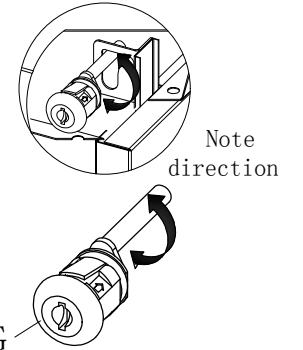

c: As the L mounted to the drawer, and with T connection U, H, J

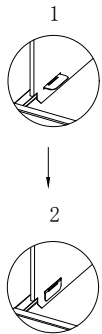

d: Installation shown in Figure K; M to install I, and with R fixed

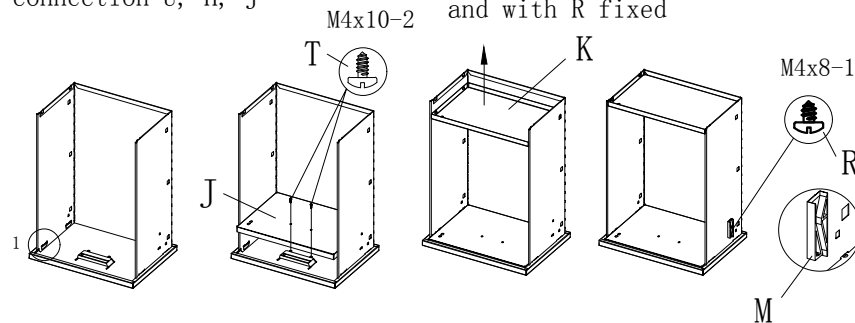



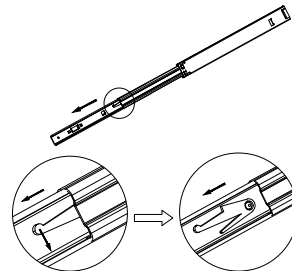

e: When installing refer to the figure pulled sled L

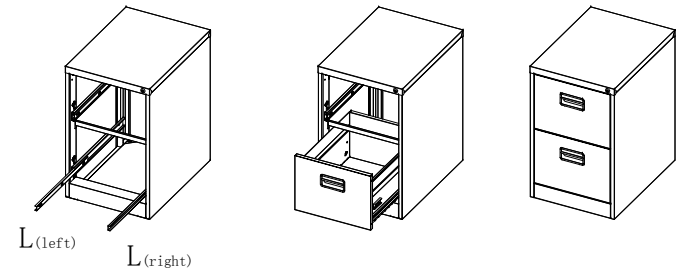

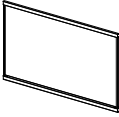
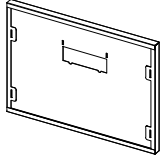
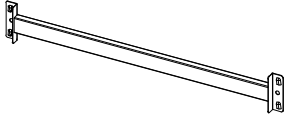
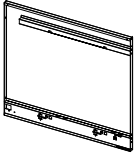
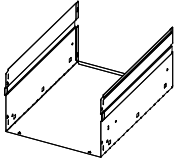
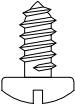
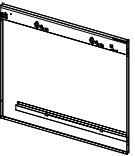
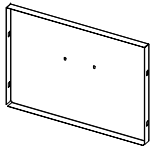
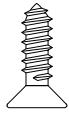
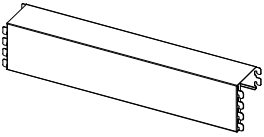
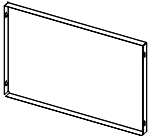
7: Packed onto the drawer on the cabinet (installed)

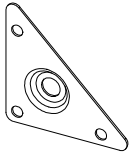
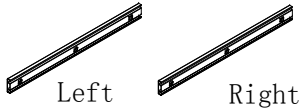
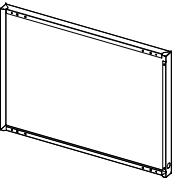
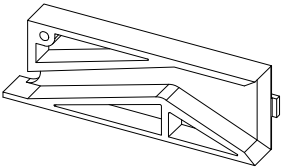

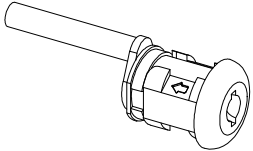
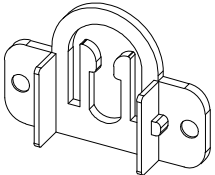
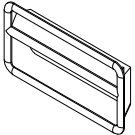
Part ID	Description	Illustration	Qty	Part ID	Description	Illustration	Qty	Part ID	Description	Illustration	Qty
A	Back		1	H	Drawer panel		2	O	Rod		1
B	Left side plate		1	I	Drawer Doo Wai		2	P	Screws M5*12		20
C	Right side plate		1	J	Front Closed		2	Q	Screws M4*16		2
D	Lower frame		1	K	After plugging		2	R	Screws M4*8		2
E	Connecting piece		4	L	Track		2	S			
F	Top		1	M	Interlock block		2	T	Screws M4*10		4
G	Lock		1	N	Interlock snap		1	U	Hand-clasping		2