

BZ-C-DZA Installation Instructions

Part ID	Description	Illustration	Qty
A	Left Side Panel		1
B	Right Side Panel		1
C	Rear Wall		1
D	Front Frame		1
E	Top		1
F	Bottom		1
G	Middle side		1
H	Shelf	Big	2
I	Shelf	Small	1
J	bulkhead door	Bottom	1
K	Inner door		1
L	bulkhead door	Top	1
M	Left door		1
N	Right door		1

1: Screw the A and B to C installation

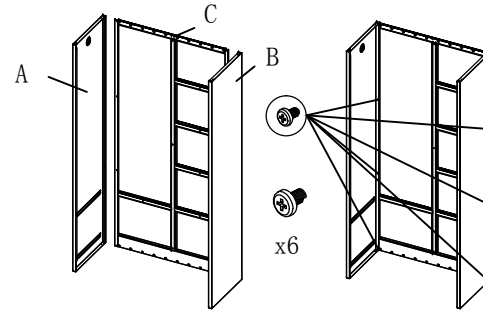

2: As shown, attached to the D A, B inside

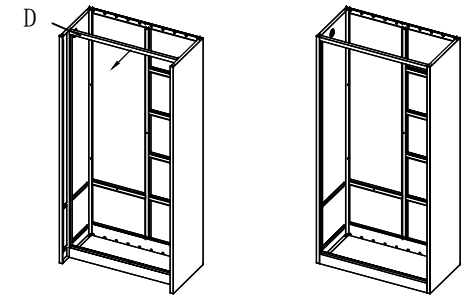

3: Screw the E, F attached to the cabinet

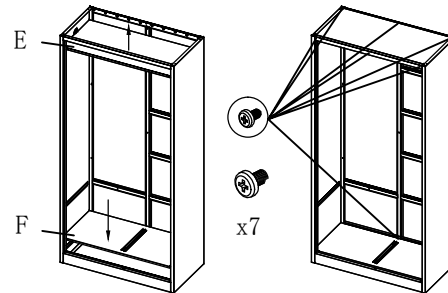

4: Mounting direction shown in FIG. G, and screw Fixed

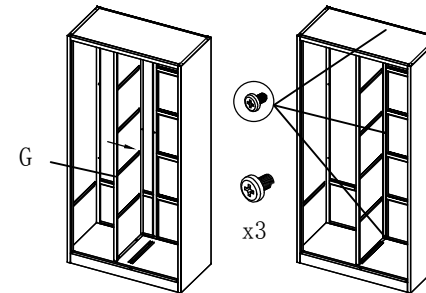

5: Respectively mounted L, H, I to the cabinet with screws Fixed, as shown below

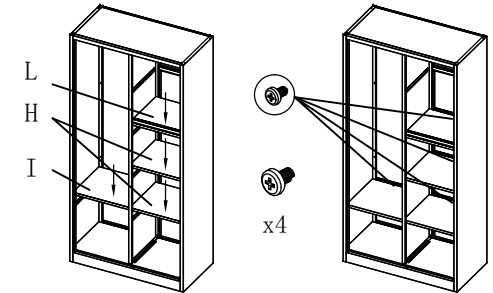

6: The K L attached to the card slot on the

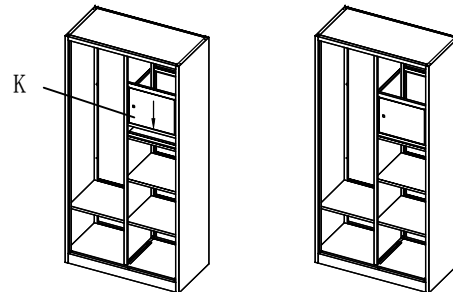

7: L to cabinet installation, with screws (Note that when you install K L attached to the slot on)

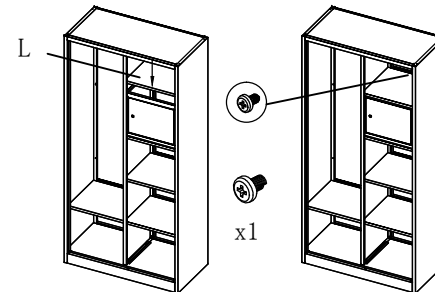

8. As shown, the mounting M, N to cabinet

