

# BZ-F-D2W Installation Instructions

1. O and P in turn is mounted to the A, B, and with screws P, rivet attention on the mounting position O  
(Interlocking parts of the drawing are no longer displayed in the back step)

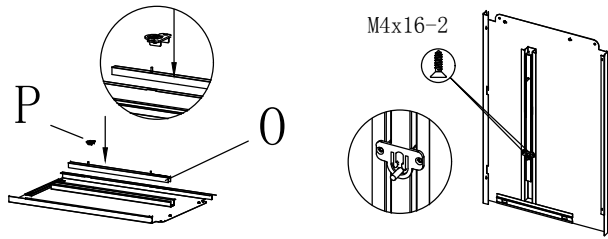

2. Save the A and B into C

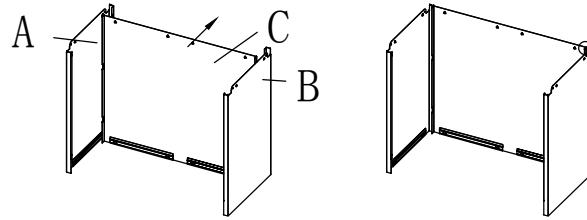

3. As shown, the D is mounted to E

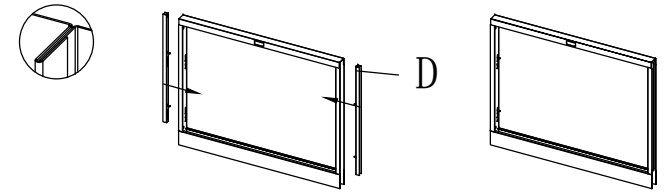

6. Assembled according to the following sequence diagram drawer

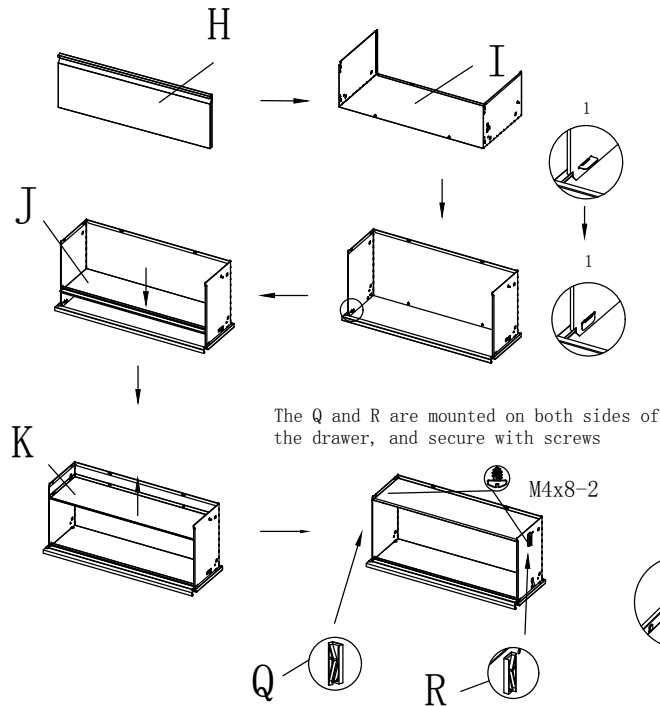

4. Install the E to the cabinet

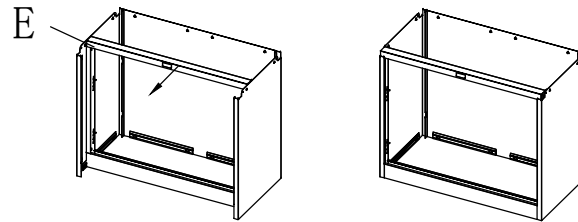

5. F and G respectively mounted to the cabinet

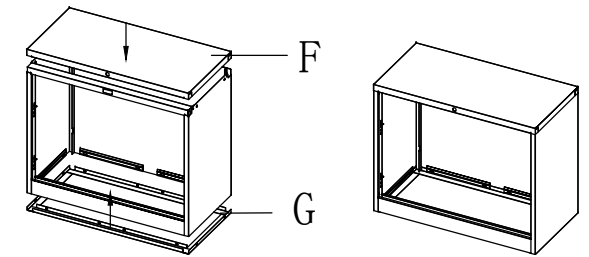



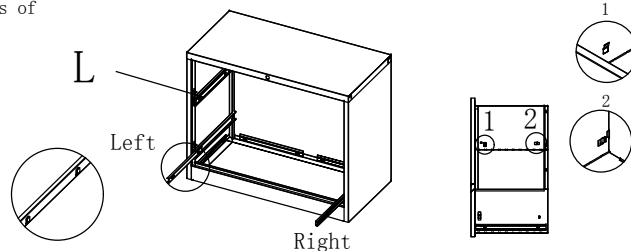

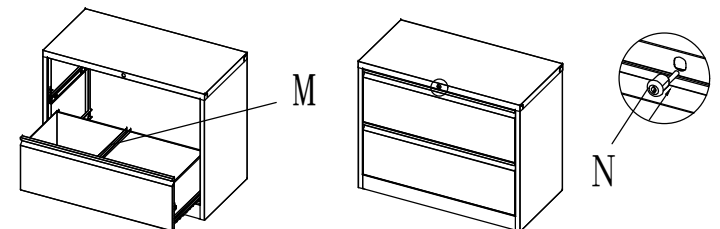

7. The L attached to the cabinet, pay attention at about L

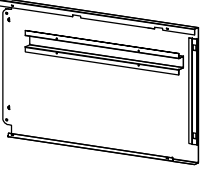
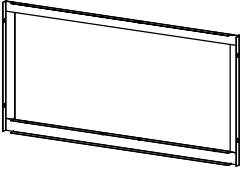

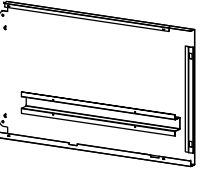
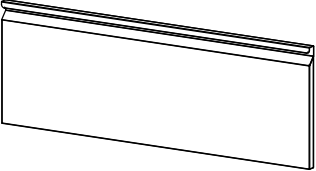
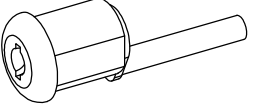
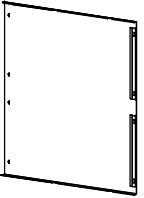
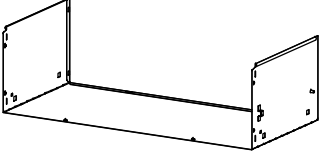
8. Install the assembled drawer cabinet and fitted with M and N

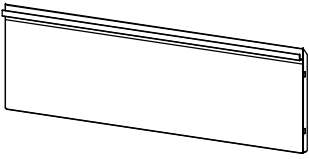
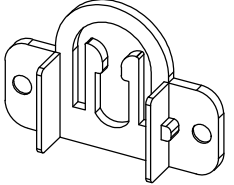
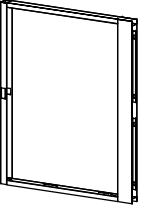
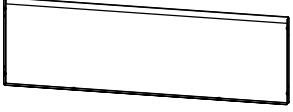
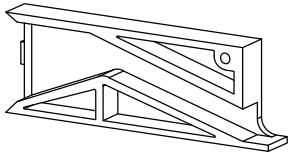
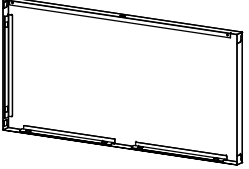

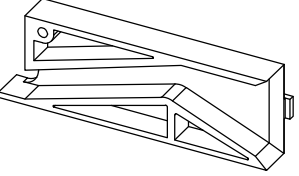
Part ID	Description	Illustration	Qty	Part ID	Description	Illustration	Qty	Part ID	Description	Illustration	Qty
A	Left side plate		1	G	Bottom frame		1	M	Prop rod		4
B	Right side plate		1	H	Face of Drawer		2	N	Lock		1
C	Rear Wall		1	I	Side of Drawer		2	O	Interlock bar		2
D	Lock lever		2	J	Front of Drawer		2	P	Interlock snap		2
E	Front frame		1	K	Back of Drawer		2	Q	Interlock block (Left)		2
F	Top		1	L	Slide		2	R	Interlock block (Right)		2