

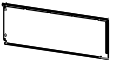

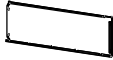







# BZ-F-D4W Installation Instructions

Part ID	Description	Illustration	Qty
A	Left side plate		1
B	Right side plate		1
C	Rear Wall		1
D	Lock lever		2
E	Front frame		1
F	Top		1
G	Bottom frame		1
H	Face of Drawer		4
I	Side of Drawer		4
J	Front of Drawer		4
K	Back of Drawer		4
L	Slide Left Right		4
M	Prop rod		8
N	Lock		1

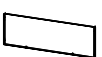

5. Assembled according to the following sequence diagram drawer

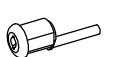
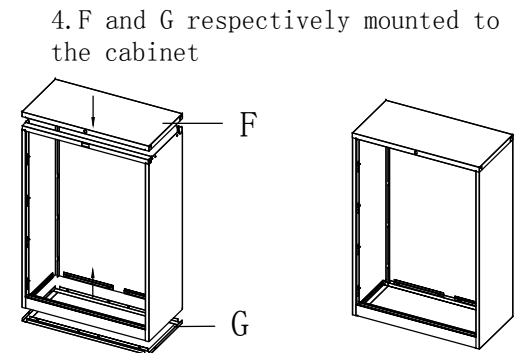
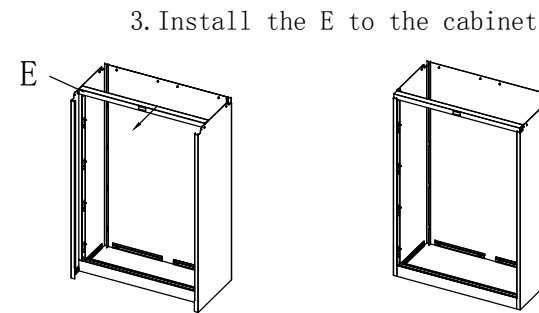
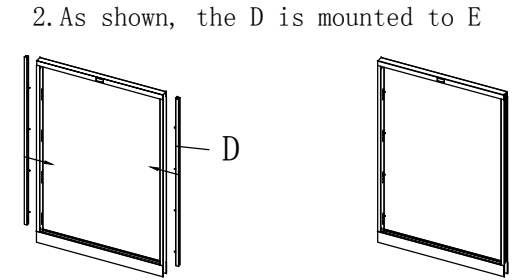
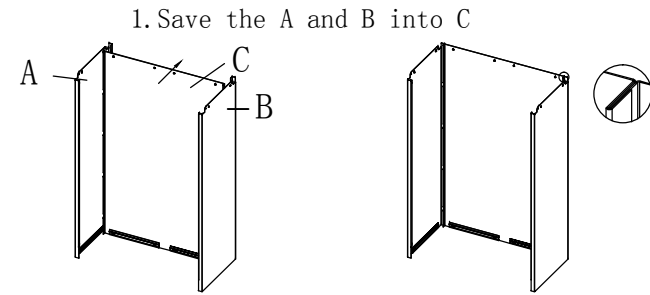
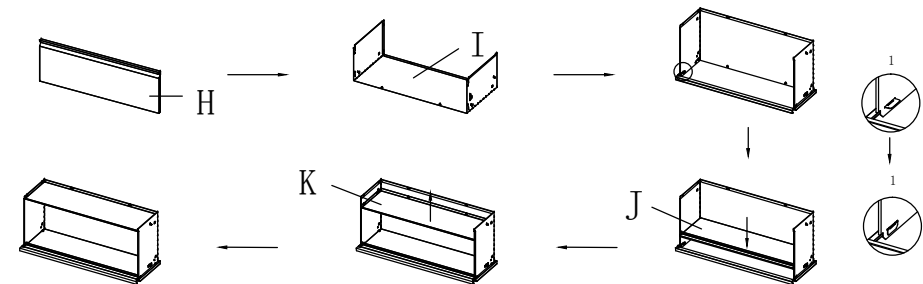

6. The L attached to the cabinet, pay attention at about L

7. Install the assembled drawer cabinet and fitted with M and N

