

# Vertical File Cabinet Installation Instructions

1: As shown, with Q fixed at C on the N

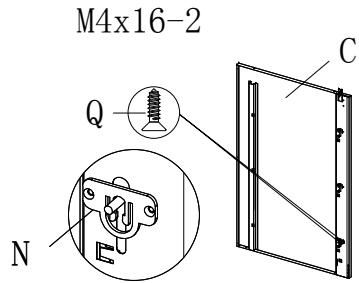

2: The B, C mounting onto A, with P fixed

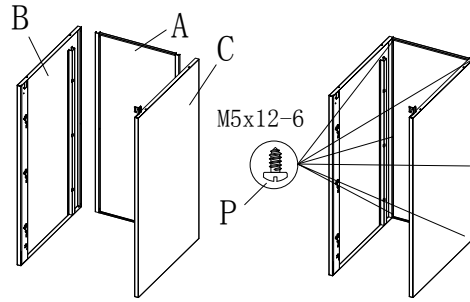

3: D as shown in the attached to B, C

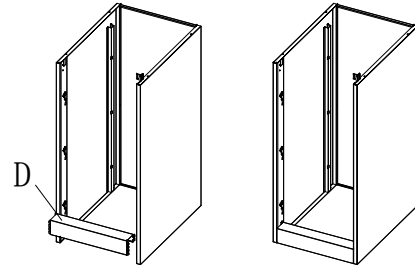

4: The O, E as shown mounted to the cabinet, With P fixed E

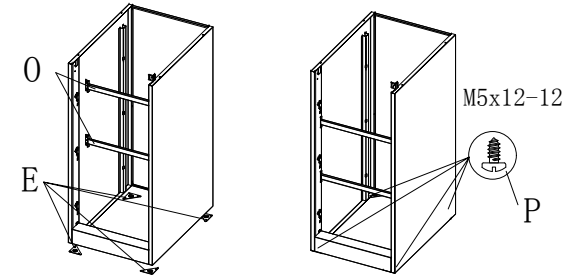

a:

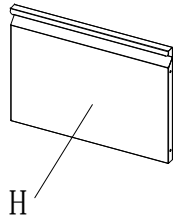

b: Open I

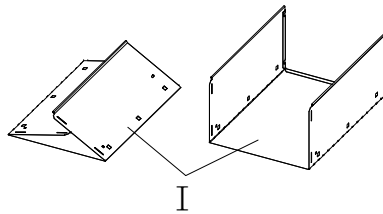

5: F to cabinet installation, with P fixed

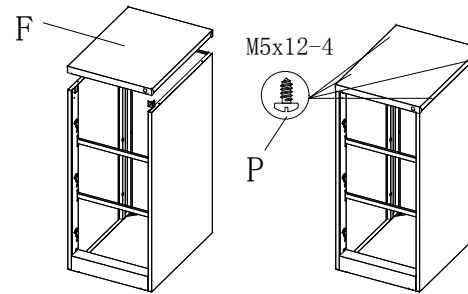

6: As shown installed rails L, G locks (When installing G, there is a note that locks the arrow side up, the rotational direction of the latch is shown below)

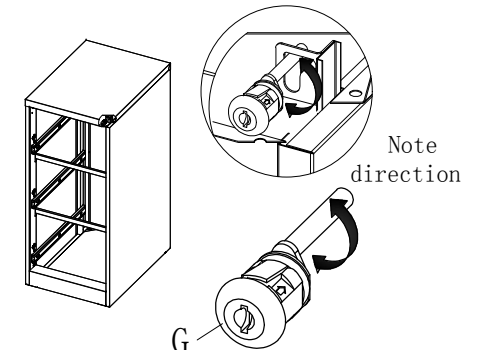

d: Installation shown in Figure K; M to install I, and with R fixed

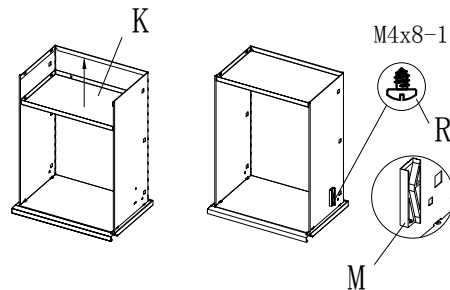

e: When installing refer to the figure pulled sled L

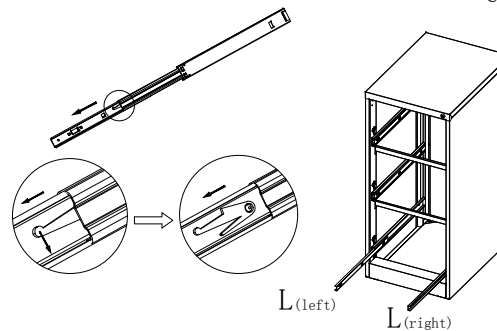

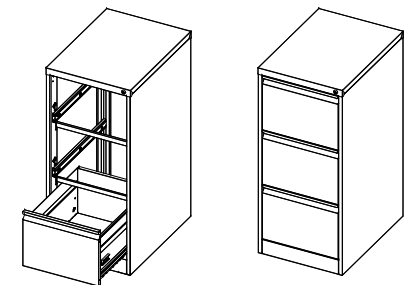

7: Packed onto the drawer on the cabinet (installed)

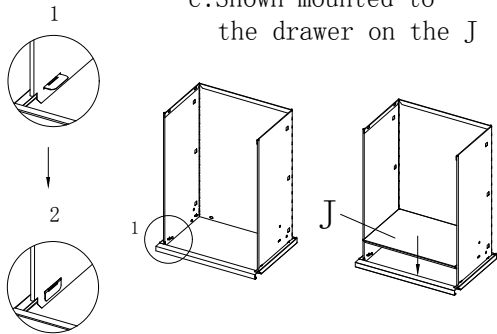

c: Shown mounted to the drawer on the J

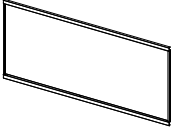
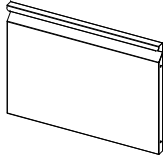
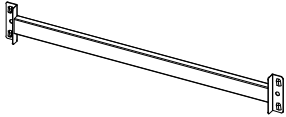
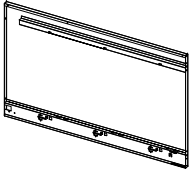
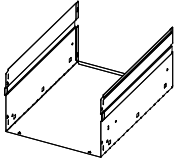
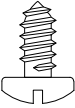
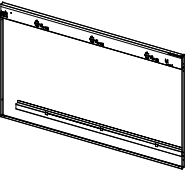
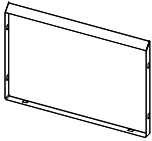
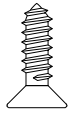
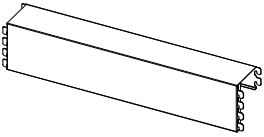
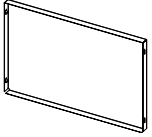

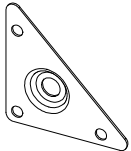
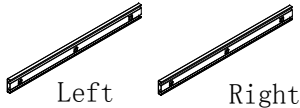
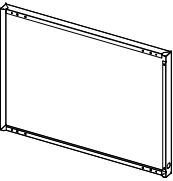
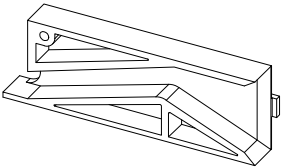
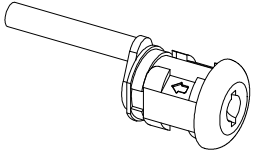
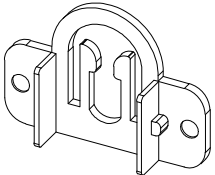
Part ID	Description	Illustration	Qty	Part ID	Description	Illustration	Qty	Part ID	Description	Illustration	Qty
A	Back		1	H	Drawer panel		3	O	Rod		2
B	Left side plate		1	I	Drawer Doo Wai		3	P	Screws M5*12		22
C	Right side plate		1	J	Front Closed		3	Q	Screws M4*16		2
D	Lower frame		1	K	After plugging		3	R	Screws M4*8		3
E	Connecting piece		4	L	Track		3	S			
F	Top		1	M	Interlock block		3	T			
G	Lock		1	N	Interlock snap		1	U			