

Vertical File Cabinet Installation Instructions

1: As shown, with Q fixed at C on the N

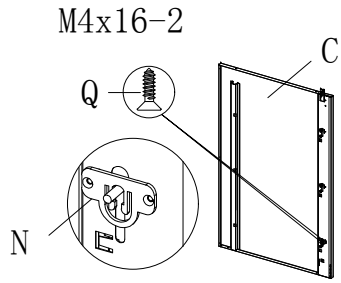

2: The B, C mounting onto A, with P fixed

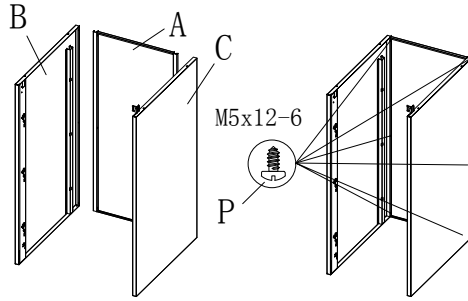

3: D as shown in the attached to B, C

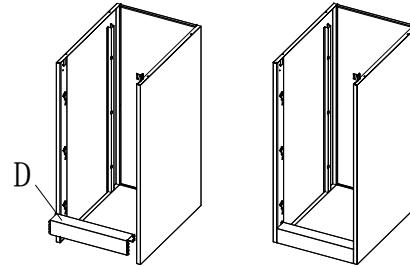

4: The O, E as shown mounted to the cabinet, With P fixed E

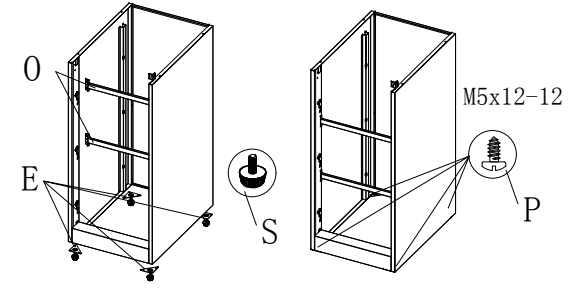

a: Install U to H

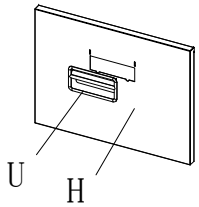

b: Open I

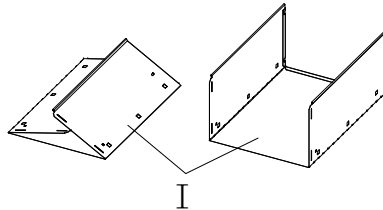

5: F to cabinet installation, with P fixed

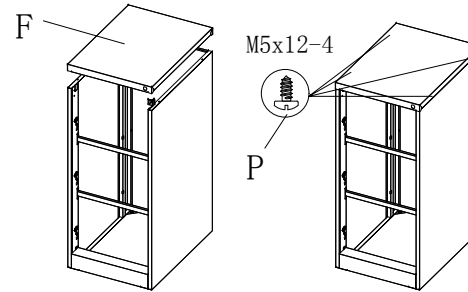

6: As shown installed rails L, G locks (When installing G, there is a note that locks the arrow side up, the rotational direction of the latch is shown below)

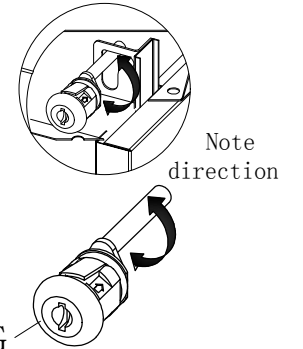

c: As the L mounted to the drawer, and with T connection U, H, J

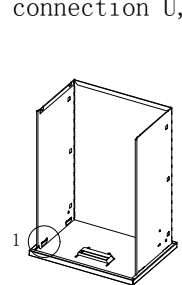
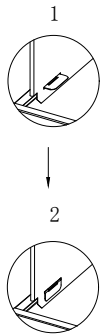

d: Installation shown in Figure K; M to install I, and with R fixed

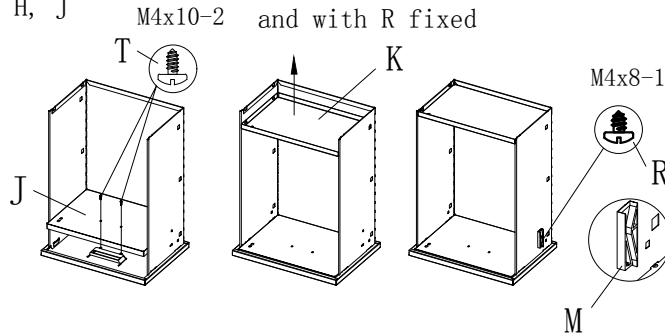



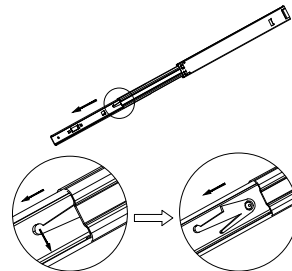

e: When installing refer to the figure pulled sled L

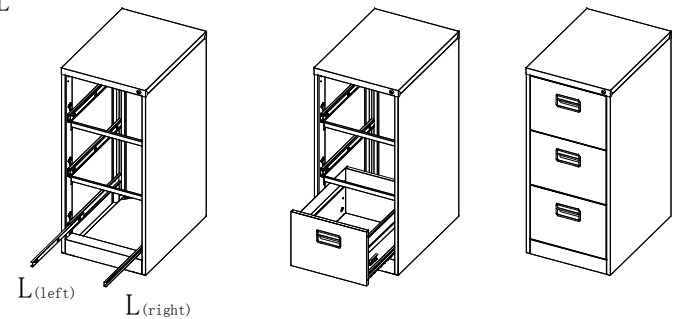

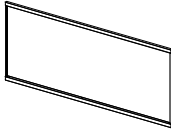
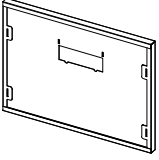
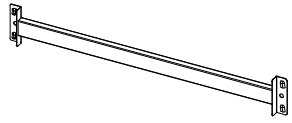
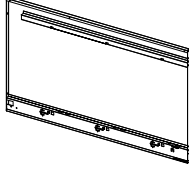
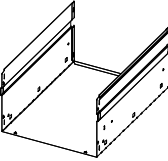
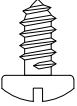
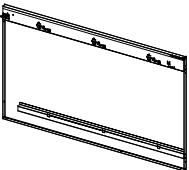
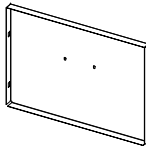
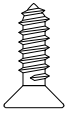
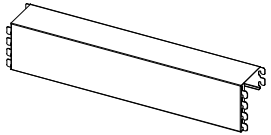
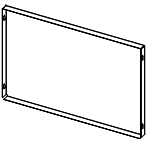
7: Packed onto the drawer on the cabinet (installed)

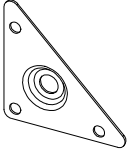
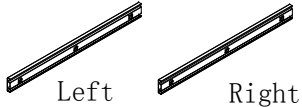
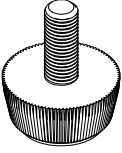
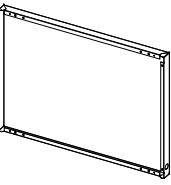
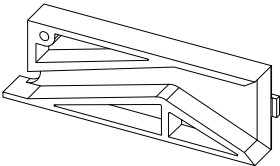

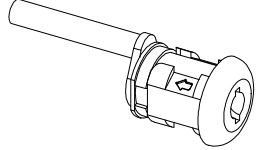
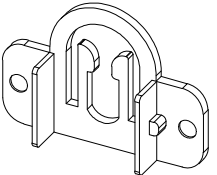
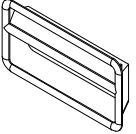
| Part ID | Description | Illustration | Qty | Part ID | Description | Illustration | Qty | Part ID | Description | Illustration | Qty |
|---------|------------------|---|-----|---------|-----------------|---|-----|---------|-----------------|---|-----|
| A | Back |  | 1 | H | Drawer panel |  | 3 | O | Rod |  | 2 |
| B | Left side plate |  | 1 | I | Drawer Doo Wai |  | 3 | P | Screws M5*12 |  | 22 |
| C | Right side plate |  | 1 | J | Front Closed |  | 3 | Q | Screws M4*16 |  | 2 |
| D | Lower frame |  | 1 | K | After plugging |  | 3 | R | Screws M4*8 |  | 3 |
| E | Connecting piece |  | 4 | L | Track |  | 3 | S | Adjustable feet |  | 4 |
| F | Top |  | 1 | M | Interlock block |  | 3 | T | Screws M4*10 |  | 6 |
| G | Lock |  | 1 | N | Interlock snap |  | 1 | U | Hand-clasping |  | 3 |